

# PHANTOM 3 SE

User Manual V1.0

2017.07

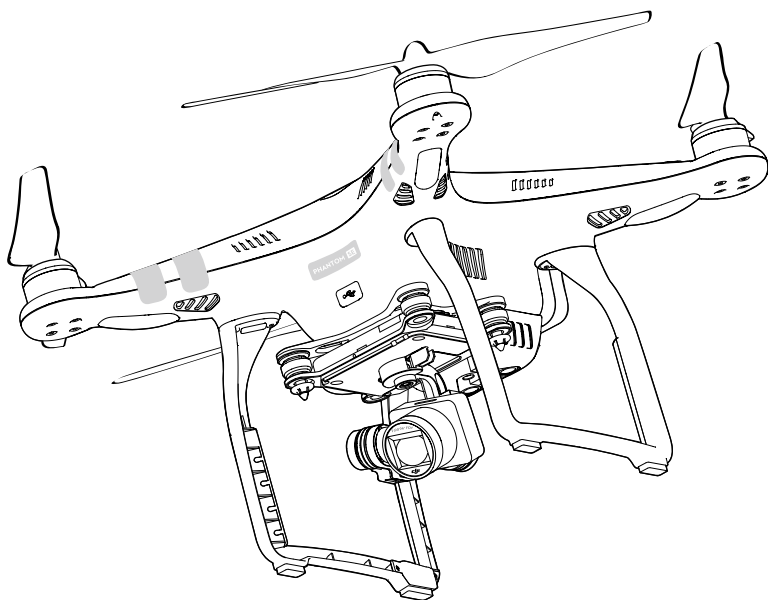

## Searching for Keywords

Search for keywords such as “battery” and “install” to find a topic. If you are using Adobe Acrobat Reader to read this document, press Ctrl+F on Windows or Command+F on Mac to begin a search.

## Navigating to a Topic

View a complete list of topics in the table of contents. Click on a topic to navigate to that section.

## Printing this Document

This document supports high resolution printing.

# Using this manual

## Legends

 Warning

 Important

 Hints and Tips

 Reference

## Read Before the First Flight

Read the following documents before using the PHANTOM™ 3 SE:

1. *In the Box*
2. *Phantom 3 SE User Manual*
3. *Phantom 3 SE Quick Start Guide*
4. *Phantom 3 Disclaimer and Safety Guidelines*
5. *Phantom 3 Intelligent Flight Battery Safety Guidelines*

We recommend that you read the Disclaimer before you fly. Prepare for your first flight by reviewing the Phantom 3 SE Quick Start Guide and refer to the User Manual for more detailed information.

## Download the DJI GO App

Be sure to use the DJI GO™ app or other apps compatible with DJI aircraft during flight. Scan the QR code to the right to download the latest version.

The Android version of the DJI GO app is compatible with Android 4.1.2 or later.  
The iOS version of the DJI GO app is compatible with iOS 8.0 or later.



\* For increased safety, the flight is restricted to a height of 30 m and distance of 50 m when not connected or logged into the app during flight, including DJI GO and all apps compatible with DJI aircraft.

# Contents

<b>Using this manual</b>	2
Legends	2
Read Before the First Flight	2
Download the DJI GO App	2
<b>Product Profile</b>	6
Introduction	6
Feature Highlights	6
Preparing the Aircraft	6
Aircraft Diagram	8
Remote Controller Diagram	8
<b>Aircraft</b>	11
Flight Controller	11
Flight Mode	11
Flight Status Indicator	11
Return-to-Home (RTH)	12
Smart RTH	12
Low Battery RTH	13
Failsafe RTH	14
Vision Positioning System	15
Flight Recorder	16
Attaching and Detaching the Propellers	16
DJI Intelligent Flight Battery	18
<b>Remote Controller</b>	23
Remote Controller Profile	23
Using the Remote Controller	23
Linking the Remote Controller	28
Remote Controller Compliance Version	28
<b>Camera and Gimbal</b>	30
Camera Profile	30
Gimbal	31

<b>DJI GO App</b>	34
Equipment	34
Editor	36
SkyPixel	36
Me	36
<b>Flight</b>	38
Flight Environment Requirements	38
Flight Limits and No-Fly Zones	38
Preflight Checklist	40
Calibrating the Compass	40
Auto Takeoff and Auto Landing	41
Flight Test	42
Starting/Stopping the Motors	42
<b>Appendix</b>	45
Specifications	45
Firmwares Update	47
Intelligent Flight Mode	47
After-Sales Information	47

# Product Profile

---

This section introduces the Phantom 3 SE and lists the components of the aircraft and remote controller.

# Product Profile

## Introduction

The Phantom 3 SE represents the next generation of DJI quadcopters. It is capable of capturing 4K video and transmitting an HD video signal out of the box. The built-in camera has an integrated gimbal to maximize stability while minimizing both weight and size. Even when no GPS signal is available, the Vision Positioning System allows the aircraft to hover accurately in place.

## Feature Highlights

**Camera and Gimbal:** With the Phantom 3 SE, you're shooting 4K video at up to 30 frames per second and capturing 12 megapixel photos that look crisper and cleaner than ever. An enhanced sensor gives you greater clarity, lower noise, and better pictures than any previous flying camera.

**Wi-Fi Video Downlink:** Live HD video is streamed from the camera to the DJI GO app over Wi-Fi as you fly. A Wi-Fi range extender is built into the remote controller.

**DJI Intelligent Flight Battery:** The 4480 mAh DJI Intelligent Flight Battery features upgraded battery cells and an advanced power management system.

**Flight Controller:** The next-generation flight controller has been updated to provide a safer, more reliable flight experience. A newly implemented flight recorder stores critical data from each flight and the Vision Positioning System enhances hovering precision when flying indoors or in environments where GPS is unavailable.

## Preparing the Aircraft

### Removing Gimbal Clamp

Remove the gimbal clamp by sliding it to the right (when facing the nose of the aircraft), as shown below.

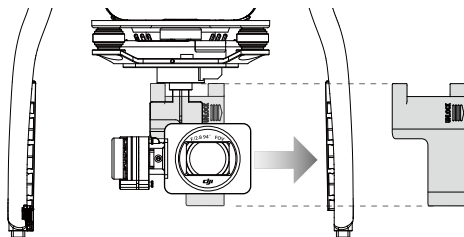

## Attaching the Propellers

Mount the propellers with black nuts on to motors with black dots and spin counter-clockwise to secure. Mount the propellers with silver nuts on to motors without dots and spin clockwise to secure. Be sure all propellers are securely in place.

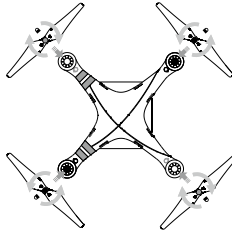

 Place all propellers onto the correct motors and tighten by hand to lock them in position.

## Battery Installation

Slide battery into the battery compartment according to the arrow's direction shown below. Make sure that you hear a click sound indicates the battery is firmly installed. Failure to do so may affect the flight safety of your aircraft.

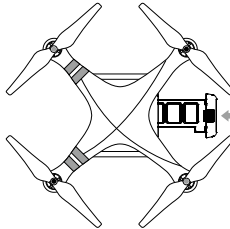

## Preparing the Remote Controller

The mobile device holder is designed for securing tablet or mobile device. Tilt the mobile device holder to the desired position.

1. Press the button on the top right side of the mobile device holder to release the clamp, then adjust the clamp to fit the size of your mobile device.
2. Secure your mobile device in the clamp by pressing down.

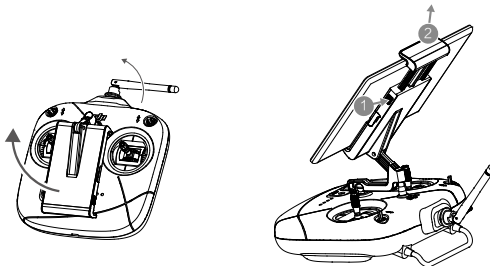

## Aircraft Diagram

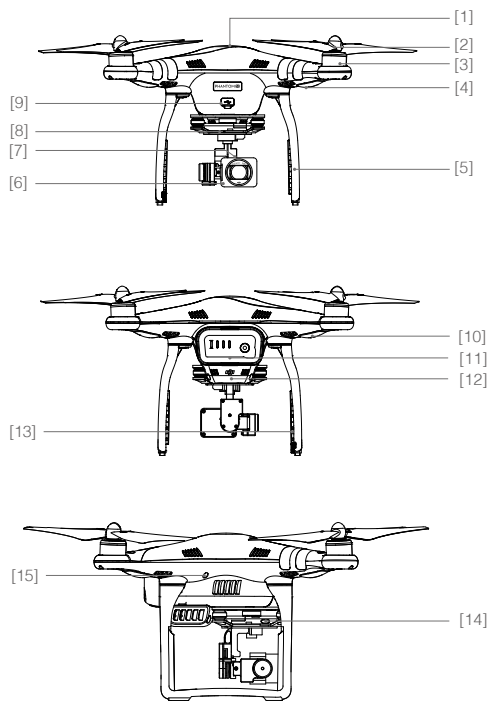

- [1] GPS
- [2] Propeller
- [3] Motor
- [4] Front LED Indicator
- [5] Landing Gear
- [6] Gimbal and Camera
- [7] Camera Micro SD Card Slot
- [8] Camera Status Indicator
- [9] Aircraft Micro USB Port
- [10] Aircraft Status Indicator
- [11] Intelligent Flight Battery
- [12] Vision Positioning Sensors
- [13] Antennas
- [14] Camera Micro USB Port
- [15] Link Button

## Remote Controller Diagram

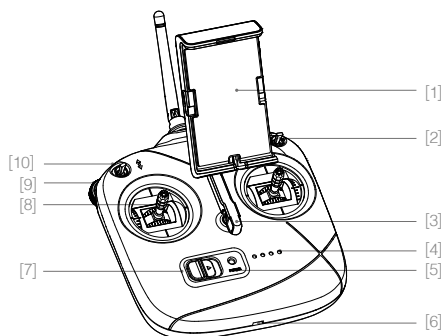

- [1] Mobile Device Holder
- [2] Switch S1
- [3] Lanyard Loop
- [4] Battery Level LEDs
- [5] Status LED
- [6] Micro USB Port
- [7] Power Switch
- [8] Control Sticks
- [9] Gimbal Dial
- [10] Switch S2



[11] Built-in Antennas

[12] Handle Bar

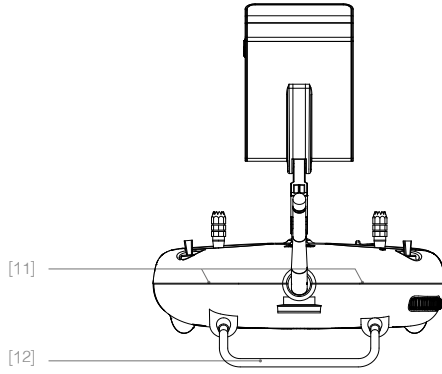

# Aircraft

---

This section introduces the features of the Flight Controller, Vision Positioning System, and the Intelligent Flight Battery

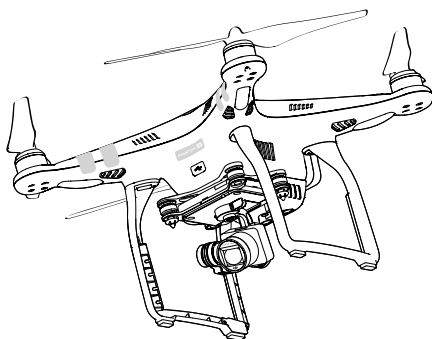

# Aircraft

## Flight Controller

The Phantom 3 SE's flight controller features several important upgrades, including a new flight mode. Safety modes include Failsafe and Return-to-Home. These features ensure the safe return of your aircraft if the control signal is lost. The flight controller can also save critical flight data from each flight to the on-board storage device. The new flight controller also provides increased stability and a new air braking feature.

## Flight Mode

Three flight modes are available. The details of each flight mode are found below:

**P-mode (Positioning):** P-mode works best when GPS signal is strong. There are three different states of P-mode, which will be automatically selected by the Phantom 3 SE depending on signal strength of GPS and Vision Positioning sensors :



**P-GPS:** GPS and Vision Positioning both are available. The aircraft is using GPS for positioning.

**P-OPTI:** Vision Positioning is available but the GPS signal strength is not sufficient. The aircraft is using only the Vision Positioning System for positioning.

**P-ATTI:** Neither GPS nor Vision Positioning is available. The aircraft is using only its barometer for positioning, so only altitude can be stabilized.

**A-mode (Attitude):** GPS and Vision Positioning System are not used for stabilization. The aircraft only uses its barometer. The aircraft can still automatically return to the home point if the control signal is lost and the Home Point was recorded successfully.

**F-mode (Function):** Intelligent Flight Mode is activated in this mode. Refer to the Appendix for more information.

 Use the S1 switch to change the flight mode of the aircraft. The Flight Mode is locked in P Mode by default, regardless of switch position. To switch flight modes, go to Camera view in the DJI GO app, tap  and enable "Multiple Flight Modes".

## Flight Status Indicator



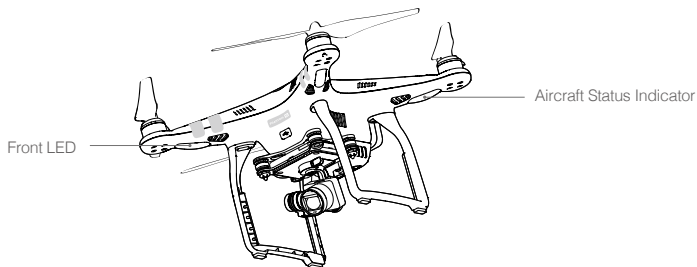

The Phantom 3 SE has Front LEDs and Aircraft Status Indicators. The positions of these LEDs are shown in the figure below:



The Front LEDs show the orientation of the aircraft. The Front LEDs glow solid red when the aircraft is turned on to indicate the front (or nose) of the aircraft. The Aircraft Status Indicators communicate the system status of the flight controller. Refer to the table below for more information about the Aircraft Status Indicators.

## Aircraft Status Indicator Description

### Normal



	Red, Green and Yellow Flash Alternately	Turning On and Self Diagnostic Testing
	Green and Yellow Flash Alternately	Warming Up
	Green Flashes Slowly	P-mode with GPS and Vision Positioning
	Green Flashes Twice	P-mode with Vision Positioning but without GPS
	Yellow Flashes Slowly	A-mode but No GPS and Vision Positioning

### Warning

	Fast Yellow Flashing	Remote Controller's Signal Lost
	Slow Red Flashing	Low Battery Warning
	Fast Red Flashing	Critical Low Battery Warning
	Red Flashing Alternately	IMU Error
	Solid Red	Critical Error
	Red and Yellow Flash Alternately	Compass Calibration Required

## Return-to-Home (RTH)

The Return-to-Home (RTH) function brings the aircraft back to the last recorded Home Point. There are three types of RTH procedures: Smart RTH, Low Battery RTH, and Failsafe RTH. This section describes these three scenarios in detail.

	GPS	Description
Home Point		If a strong GPS signal was acquired before takeoff, the Home Point is the location from which the aircraft was launched. The GPS signal strength is indicated by the GPS icon (  ). The aircraft status indicator will blink rapidly when the home point is recorded.

## Smart RTH

Tap in the DJI GO app or toggle the S2 switch on the remote controller back and forth at least twice to initiate Smart RTH. The aircraft will first ascend to the Return-to-Home altitude, then return to the last recorded Home Point if a GPS signal is available. During the RTH procedure, you may use the remote controller to guide the aircraft around obstacles.

Tap in the DJI GO app or toggle the S1 switch once to terminate Smart RTH and regain full control of the aircraft.

## Low Battery RTH

The low battery level failsafe is triggered when the DJI Intelligent Flight Battery is depleted to a point that may affect the safe return of the aircraft. Users are advised to return home or land the aircraft immediately when prompted. The DJI GO app will display a notice when a low battery warning is triggered. The aircraft will automatically return to the Home Point if no action is taken after a ten-second countdown. The user can cancel the RTH procedure. The thresholds for these warnings are automatically determined based on the aircraft's current altitude and distance from the Home Point.

The aircraft will land automatically if the current battery level can only support the aircraft long enough to descend from its current altitude. The user can still use the remote controller to alter the aircraft's orientation during the landing process.

The Battery Level Indicator is displayed in the DJI GO app, and is described below:

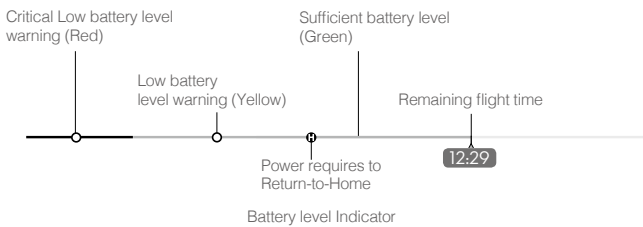

Battery Level Warning	Remark	Aircraft Status Indicator	DJI GO app	Flight Instructions
Low battery level warning	The battery power is low. Please land the aircraft.	Aircraft status indicator blinks RED slowly.	Tap "Go-home" to have the aircraft return to the Home point and land automatically, or "Cancel" to resume normal flight. If no action is taken, the aircraft will automatically go home and land after 10 seconds. Remote controller will sound an alarm.	Fly the aircraft back and land it as soon as possible, then stop the motors and replace the battery.
Critical Low battery level warning	The aircraft must land immediately.	Aircraft status indicator blinks RED quickly.	The DJI GO app display will flash red and the aircraft will start to descend. The remote controller will sound an alarm.	Allow the aircraft to descend and land automatically.
Estimated remaining flight time	Estimated remaining flight based on current battery level.	N/A	N/A	N/A

- When Critical battery level warning is triggered and the aircraft begins to land automatically, you may push the throttle upward to make the aircraft hover at its current altitude, giving you an opportunity to navigate to a more appropriate landing location.
- The colored zones and markers on the battery level indicator bar reflect the estimated remaining flight time. They are automatically adjusted according to the aircraft's current location and status.

## Failsafe RTH

If the Home Point was successfully recorded and the compass is functioning normally, Failsafe RTH will be automatically activated if the remote controller signal is lost for more than three seconds. The Return-to-Home process may be interrupted and the operator may regain control of the aircraft if the remote controller signal connection is re-established.

### Failsafe Illustration

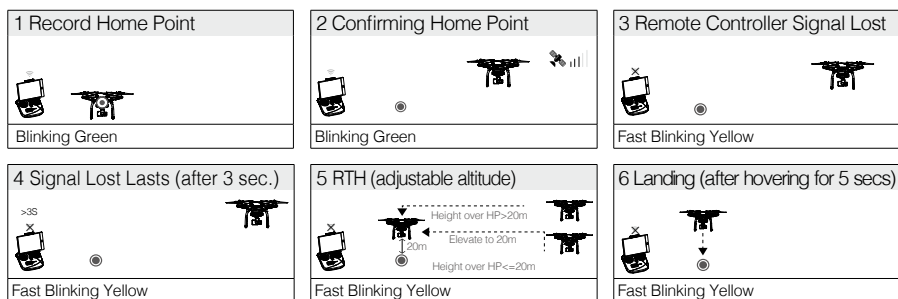





- ⚠ Aircraft cannot return to the Home Point when GPS signal is weak or unavailable.
- Aircraft automatically descends and lands if RTH is triggered when the aircraft flies within a 20 meters (65 feet) radius of the Home Point. Aircraft will stop ascending and immediately return to the Home Point if you move the throttle stick if the aircraft reaches 20 meters (65 feet) altitudes or beyond during Failsafe.
- The aircraft cannot avoid obstruction during the Failsafe RTH, therefore, it is important to set an suitable Failsafe altitude before each flight. Launch the DJI GO app and enter "Camera" and tap  to set the Failsafe altitude.
- User cannot control the aircraft while the aircraft is ascending to its failsafe altitude. User can toggle the S1 switch to exit ascending and regain control.

### Failsafe Safety Notices



The aircraft cannot avoid obstruction during the Failsafe RTH, therefore, it is important to set an suitable Failsafe altitude before each flight. Launch the DJI GO app and enter "Camera" and tap  to set the Failsafe altitude.

	<p>If the aircraft is flying under 20 meters (65 feet) and Failsafe (including Smart RTH, Lower Battery RTH ) is triggered, the aircraft will first automatically ascend to 20 meters (65 feet) from the current altitude. You can only cancel the ascending by exiting the Failsafe.</p>
	<p>Aircraft automatically descends and lands if RTH is triggered when the aircraft flies within a 20 meters (65 feet) radius of the Home Point. Aircraft will stop ascending and immediately return to the Home Point if you move the throttle stick if the aircraft reaches 20 meters (65 feet) altitudes or beyond during Failsafe.</p>
	<p>Aircraft cannot return to the Home Point when GPS signal is weak ( [  ] displays grey) or unavailable.</p>
	<p>If you move the throttle stick after the aircraft rises above 65 feet (20m) but below the pre-set Failsafe RTH altitude, the aircraft will stop ascending and immediately return to the Home Point.</p>

## Vision Positioning System

The DJI Vision Positioning System uses ultrasound and image data to help the aircraft maintain its current position. With the help of Vision Positioning, your Phantom 3 SE can hover in place more precisely and fly indoors or in other environments where a GPS signal is not available. The main components of the Vision Positioning System are located on the bottom of your Phantom 3 SE; they include [1] one monocular camera and [2] two ultrasonic sensors.

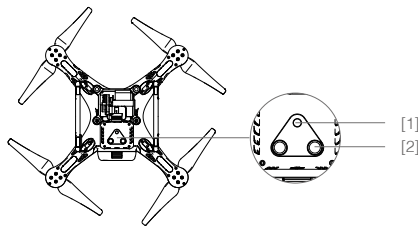

### Using Vision Positioning

Vision Positioning is activated automatically when the Phantom 3 SE is turned on. No further action is required. Vision Positioning is typically used in indoor environments, where GPS is unavailable.

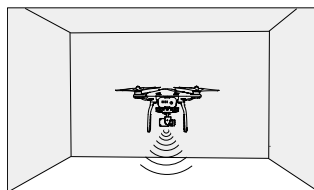

Follow the steps below to use Vision Positioning:

1. Toggle the S1 switch to the upper most position.
2. Place the aircraft on a flat surface. Note that the Vision Positioning system cannot work properly on surfaces without clear pattern variations.
3. Turn on the aircraft. The aircraft status indicator will flash green two times, which indicates the Vision Positioning system is ready. Gently push the throttle up to lift off and the aircraft will hover in place.

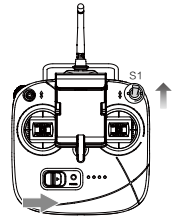

**⚠** The performance of your Vision Positioning System is affected by the surface over which it is flying. The ultrasonic sensors may not be able to accurately measure distances when operating above sound-absorbing materials. In addition, the camera may not function correctly in suboptimal environments. The aircraft will switch from P-mode to A-mode automatically if neither GPS nor Vision Positioning System are available. Operate the aircraft with great caution in the following situations:

- Flying close to the ground (below 0.5 meters) at fast speeds.
- Flying over monochrome surfaces (e.g. pure black, pure white, pure red, pure green).
- Flying over a highly reflective surfaces.
- Flying at high speeds (over 8 m/s at 2 meters or over 4 m/s at 1 meter).
- Flying over water or transparent surfaces.
- Flying over moving surfaces or objects.
- Flying in an area where the lighting changes frequently or drastically.
- Flying over extremely dark (lux < 10) or bright (lux > 100,000) surfaces.
- Flying over surfaces that can absorb sound waves (e.g. thick carpet).
- Flying over surfaces without clear patterns or texture.
- Flying over surfaces with identical repeating patterns or textures (e.g. tiles with the same design).
- Flying over inclined surfaces that will deflect sound waves away from the aircraft.

- ☀** • Keep the sensors clean at all times. Dirt or other debris may adversely affect the effectiveness of the sensors.
- Vision Positioning is only effective when the aircraft is at altitudes of 0.3 to 3 meters.
- The Vision Positioning System may not function properly when the aircraft is flying over water.
- The Vision Positioning System may not be able to recognize pattern on the ground in low light conditions (less than 100 lux).
- Do not use other ultrasonic devices with frequency of 40 KHz when Vision Positioning system is in operation.

- ⊙** Keep the animals away from the aircraft when Vision Positioning system is activated. The sonar sensor emits high frequency sounds that are only audible to some animals.





## Flight Recorder

Flight data is automatically recorded to the internal storage of the aircraft. This includes flight telemetry, aircraft status information, and other parameters. To access these data, connect the aircraft to the PC through the Micro USB port and launch the DJI GO app.

## Attaching and Detaching the Propellers

Use only DJI approved propellers with your Phantom 3 SE. The silver and black nuts on the propeller indicate where they should be attached and in which direction they should spin. To attach the propellers properly, match the nut color with the motor dot color.



Propellers	Silver Nut	Black Nut
Figure		
Attach On	Motors without dots	Motors with black dots
Legends	 Lock : Turn the propellers in the indicated direction to mount and tighten.  Unlock : Turn the propellers in the indicated direction to loosen and remove.	

## Attaching the Propellers

1. Be sure to remove the warning stickers from the motors before attaching the propellers.
2. Attach the propellers with silver nuts onto the motors without dots and spin the propellers clockwise to secure them in place. Attach the propellers with black nuts onto the motors with black dots and spin the propellers counter-clockwise to secure them in place. Be sure to tighten each propeller by hand before flight.

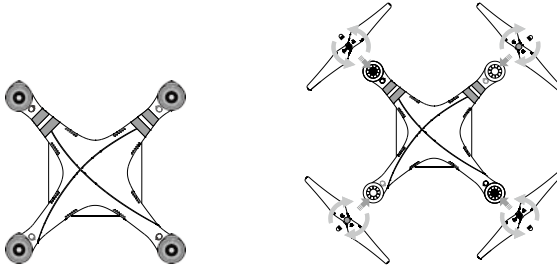

- Check that the propellers and motors are installed correctly and firmly before every flight.
- ONLY use original DJI propellers for a better and safer flight experience.
- ONLY using the propller with the same model.
- Tighten the propellers with both hands before each flight.
- Ensure that all propellers are in good condition before each flight. DO NOT use aged, chipped, or broken propellers.
- Stand clear of the motors and DO NOT touch the propellers when they are spinning.

## Detaching the Propellers

Put the propeller removal clamp around the motor, and pinch both sides as shown below to hold the motor in place. Then rotate the propeller in the unlock direction to loosen it.

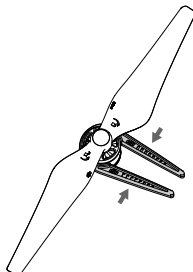

## DJI Intelligent Flight Battery

The DJI Intelligent Flight Battery has a capacity of 4480 mAh, a voltage of 15.2 V, and a smart charge/discharge functionality. It should only be charged using an appropriate charger that has been approved by DJI.

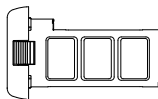

Intelligent Flight Battery

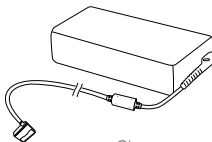

Charger

 The Intelligent Flight Battery must be fully charged before using it for the first time.

### DJI Intelligent Flight Battery Functions

1. Battery Level Display: the LED indicators display the current battery level.
2. Battery Life Display: the LEDs display the current battery power cycle.
3. Auto-Discharging Function: To prevent swelling, the battery automatically discharges to below 65% of total power when it is idle for more than ten days. It takes around two days to discharge the battery to 65%. It is normal to feel moderate heat being emitted from the battery during the discharge process. Discharge thresholds can be set in the DJI GO app.
4. Balanced Charging: Automatically balances the voltage of each battery cell when charging.
5. Overcharge Protection: Charging automatically stops when the battery is fully charged.
6. Temperature Detection: The battery will only charge when the temperature is between 5°C (41°F) and 40°C (104°F).
7. Over Current Protection: The battery stops charging when high amperage (more than 8 A) is detected.
8. Over Discharge Protection: To prevent over-discharge damage, discharging automatically stops when the battery voltage reaches 12 V.
9. Short Circuit Protection: Automatically cuts the power supply when a short circuit is detected.
10. Battery Cell Damage Protection: The DJI GO app displays a warning message when a damaged battery cell is detected.
11. Battery Error History: Browse the battery error history in the DJI GO app.
12. Sleep Mode: To save power, the battery enters sleep mode after 20 minutes of inactivity.
13. Communication: Information pertaining to the battery's voltage, capacity, current, etc. is transmitted to the aircraft's main controller.

 Refer to *Phantom 3 SE Intelligent Flight Battery Safety Guidelines* before use. Users take full responsibility for all operations and usage.

### Using the Battery

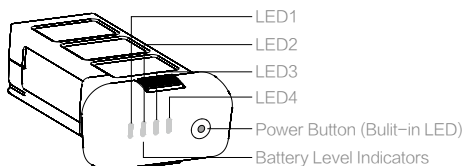

## Turning ON/OFF

**Turning On:** Press the Power Button once, then press again and hold for 2 seconds to turn on. The Power LED will turn red and the Battery Level Indicators will display the current battery level.

**Turning Off:** Press the Power Button once, then press again and hold for 2 seconds to turn off. The battery power LED will flash when powering off the Phantom to allow automatically stopping of a recording during the event recording wasn't stopped.

## Low Temperature Notice

1. Battery capacity is significantly reduced when flying in low temperature (< 0°C) environments.
2. It is not recommended that the battery be used in extremely low temperature (< -10°C) environments. Battery voltage should reach the appropriate level when operating environment with temperatures between -10°C and 5°C.
3. End the flight as soon as the DJI GO app displays the "Low Battery Level Warning" in low temperature environments.
4. Keep the battery indoors to warm it before flying in low temperature environments.
5. To ensure optimal performance of the battery, keep the battery temperature above 20°C.
6. The charger will stop charging the battery if the battery cell's temperature is not within the operating range (5°C ~ 40°C).





































 In cold environments, insert the battery into the battery compartment and allow the aircraft for approximately 1-2 minutes to warm up before taking off.

## Checking the Battery Level

The Battery Level Indicators display how much power remains. When the battery is turned off, press the Power Button once. The Battery Level Indicators will light up to display the current battery level. See below for details.

 The Battery Level Indicators will also show the current battery level during charging and discharging. The indicators are defined below.

 : LED is on.       : LED is flashing.  
 : LED is off.

Battery Level Indicators				
LED1	LED2	LED3	LED4	Battery Level
				87.5%~100%
				75%~87.5%
				62.5%~75%
				50%~62.5%
				37.5%~50%
				25%~37.5%
				12.5%~25%
				0%~12.5%
				=0%

## Battery life

Battery life refers to how many more times the battery can be discharged and recharged before it must be replaced. When the battery is turned off, press and hold the Power Button for 5 seconds to check the battery life. The Battery Level Indicators will light up and/or blink for two seconds, as shown below:

Battery Level Indicators				
LED1	LED2	LED3	LED4	Battery Life
□	□	□	□	90%~100%
□	□	□	◌	80%~90%
□	□	□	□	70%~80%
□	□	◌	□	60%~70%
□	□	□	□	50%~60%
□	◌	□	□	40%~50%
□	□	□	□	30%~40%
◌	□	□	□	20%~30%
□	□	□	□	below 20%

⚠ When battery life reaches 0%, it can no longer be used.

📖 For more information about the battery, launch the DJI GO app and check the information that is listed under the battery tab.

## Charging the Intelligent Flight Battery

1. Connect the Battery Charger to a power source (100-240 V 50/60 Hz).
2. Open the Protection Cap and connect the Intelligent Flight Battery to the Battery Charger. If the battery level is above 95%, turn on the battery before charging.
3. The Battery Level Indicator will display the current battery level as it is charging.
4. The Intelligent Flight Battery is fully charged when the Battery Level Indicators are all off.
5. Air-cool the Intelligent Flight Battery after each flight. Allow its temperature to drop to room temperature before storing it for an extended period.

- ⚠
- Only use the DJI approved charger.
  - Always turn off the battery before inserting it or removing it from the Phantom 3 SE. Never insert or remove a battery when it is turned on.

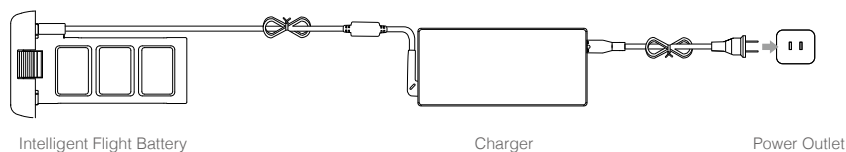

## Battery Level Indicators While Charging

LED1	LED2	LED3	LED4	Battery Level
				0%~25%
				25%~50%
				50%~75%
				75%~100%
				Fully Charged

## Battery Protection LED Display

The table below shows battery protection mechanisms and corresponding LED patterns.

## Battery Level Indicators while Charging

LED1	LED2	LED3	LED4	Blinking Pattern	Battery Protection Item
				LED2 blinks twice per second	Over current detected
				LED2 blinks three times per second	Short circuit detected
				LED3 blinks twice per second	Over charge detected
				LED3 blinks three times per second	Over-voltage charger detected
				LED4 blinks twice per second	Charging temperature is too low
				LED4 blinks three times per second	Charging temperature is too high

After these issues are resolved, press the Power Button to turn off the Battery Level Indicator. Unplug the Intelligent Flight Battery from the charger and plug it back in to resume charging. Note that you do not need to unplug and plug in the charger in the event of a room temperature error; the charger will resume charging when the temperature is within the allowable range.



DJI does not take any responsibility for damage caused by third-party chargers.



## How to discharge your Intelligent Flight Battery:

**Slow** : Place the Intelligent Flight Battery into the Phantom 3 SE's Battery Compartment and turn it on. Leave it on until there is less than 8% of power left, or until the battery can no longer be turned on. Launch the DJI GO app to check battery levels.

**Rapid** : Fly the Phantom 3 SE outdoors until there is less than 8% of power left, or until the battery can no longer be turned on.

# Remote Controller

---

This section describes the features of the remote controller and includes instructions for controlling the aircraft and the camera.

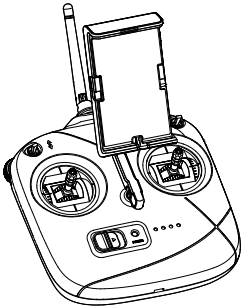

# Remote Controller

## Remote Controller Profile

The Phantom 3 SE remote controller is a multi-function wireless communication device that integrates the video downlink system and aircraft remote control system. The video downlink and aircraft remote control system operate at 2.4 GHz and 5.8 GHz. The battery level is displayed via LED indicators on the front panel of the remote controller.

- ☰ • **Compliance Version:** The remote controller is compliant with both CE and FCC regulations.
- **Operating Mode:** Control can be set to Mode 1, Mode 2 or Mode 3 or to a custom mode.
- **Mode 1:** The right stick serves as the throttle.
- **Mode 2:** The left stick serves as the throttle.

## Using the Remote Controller

### Turning the Remote Controller On and Off

The Phantom 3 SE remote controller is powered by a rechargeable battery that has a capacity of 2600 mAh. The battery level is indicated via the Battery Level LEDs on the front panel.

1. Slide the power switch to the right to turn on the remote controller.
2. The Status LED will light up solid green when the remote controller is connected to the aircraft. The Battery Level Indicators will display the battery level of the remote controller.

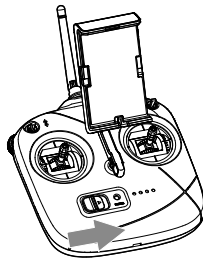

### Charging the Remote Controller

Charge the remote controller through the Micro USB port using the provided Micro USB cable.

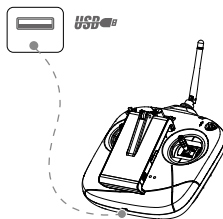

USB Adapter Charge Time:  
~2.5 hours (when charging at 1.5 A)

## Controlling Aircraft

This section explains how to control the orientation of the aircraft through the remote controller. The Remote Control is set to Mode 2 by default.

### Mode 1

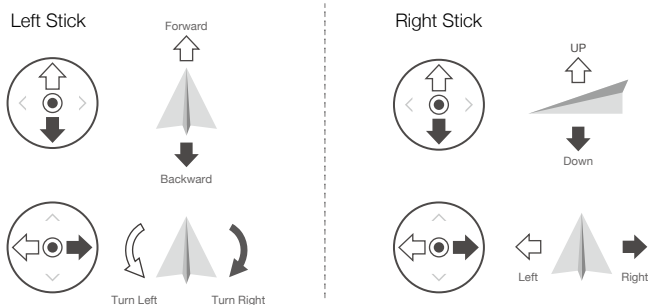

### Mode 2

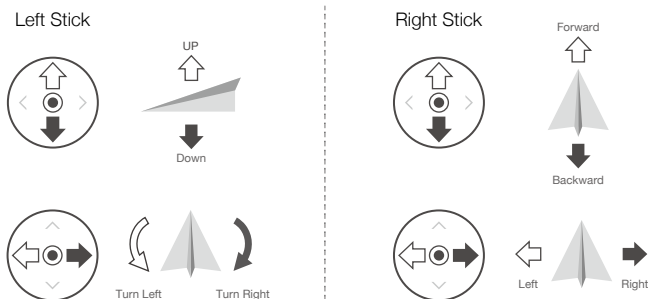



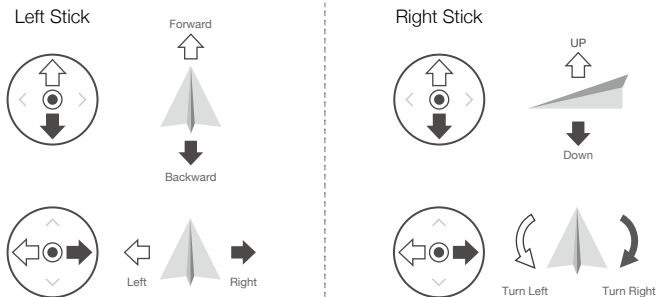



### Mode 3

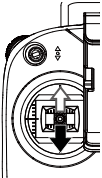
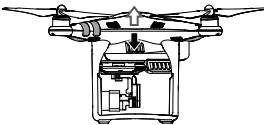
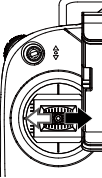

Stick Neutral/Mid-Point: Control sticks are in the center position.

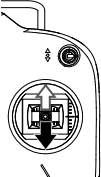
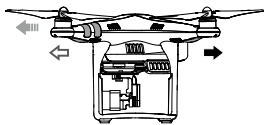
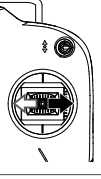
Moving the Control Stick: The control stick is pushed away from the center position.

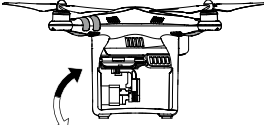
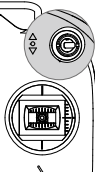

Remote Controller (Mode 2)	Aircraft ( ← Indicates Nose Direction)	Remarks
		<p>Moving the left stick up and down changes the aircraft's elevation.</p> <p>Push the stick up to ascend and down to descend. When both sticks are centered, the Phantom 3 SE will hover in place.</p> <p>The more the stick is pushed away from the center position, the faster the Phantom 3 SE will change elevation. Always push the stick gently to prevent sudden and unexpected elevation changes.</p>
		<p>Moving the left stick to the left or right controls the rudder and rotation of the aircraft.</p> <p>Push the stick left to rotate the aircraft counter-clockwise, push the stick right to rotate the aircraft clockwise. If the stick is centered, the Phantom 3 SE will maintain its current orientation.</p> <p>The more the stick is pushed away from the center position, the faster the Phantom 3 SE will rotate.</p>
		<p>Moving the right stick up and down changes the aircraft's forward and backward pitch.</p> <p>Push the stick up to fly forward and down to fly backward. Phantom 3 SE will hover in place if the stick is centered.</p> <p>Push the stick further away from the center position for a larger pitch angle (maximum 30°) and faster flight.</p>
		<p>Moving the right stick control left and right changes the aircraft's left and right pitch.</p> <p>Push left to fly left and right to fly right. The Phantom 3 SE will hover in place if the stick is centered.</p>
		<p>Gimbal Dial: Turn the dial to the right, and the camera will shift to point upwards. Turn the dial to the left, and the camera will shift to point downwards. The camera will remain in its current position when dial is static.</p>
	 position-1/position-2/position-3	<p>Toggle the S1 switch back and forth to regain the control of the aircraft during Failsafe RTH.</p> <p>Toggle the S1 switch back and forth for more than 3 times to calibrate the aircraft's compass.</p> <p>Toggle the S1 switch to position 1 to enable P-Mode, to position 2 to enable A-Mode, and to position 3 to enable F-Mode.</p>

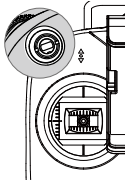

position-1/position-2/position-3

Toggle the S2 switch back and forth once to initiate Smart RTH. Use the S2 switch and the gimbal dial to link with the aircraft and reset the Wi-Fi password.

### Adjusting Controller Sticks

Hold and twist the controller sticks clockwise or counter clockwise to adjust the length of the controller sticks. A proper length of controller sticks can improve the controlling accuracy.

### Connecting to the Wi-Fi Video Downlink:

1. Switch on the remote controller.
2. Turn on the aircraft.
3. On your mobile device, select 'PHANTOM3SE-XXXXXX' from the Wi-Fi network list, and enter the default password '12341234'.
4. Launch the DJI GO app and enter Camera View. A video signal from the aircraft's camera indicates that the aircraft has established a connection to the Wi-Fi video downlink successfully.

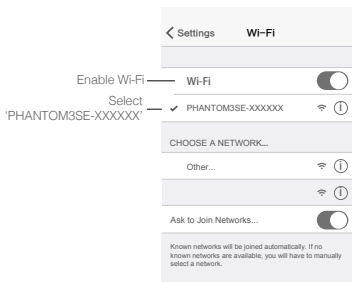

⚠ Once connected, you are advised to change the SSID and password by tapping  in Camera view.

### Resetting the Wi-Fi Video Downlink

Switch on the remote controller, turn the gimbal dial to the far right, and toggle the S2 switch back and forth for at least three times. The remote controller's status LED will blink green and red alternatively fast if the SSID and password for the Wi-Fi Video Downlink have been reset to their default values successfully.

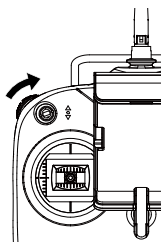

S2 Switch



## Optimal Transmission Range

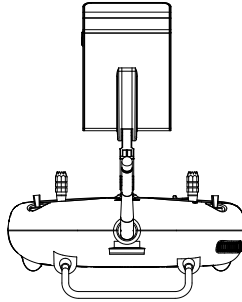

Do not obstruct the built-in antenna.

## Battery Level Indicator

The figure below illustrates the four battery levels that are displayed by the Battery Level Indicator on the remote controller's front panel.

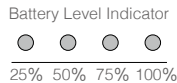

- ⚠** Always ensure the remote controller has an adequate battery level before each flight. If the battery level is critically low, the remote controller will sound an alert and its Status LED will blink red for 3 seconds before automatically powering off. If the remote controller powers off during flight, the aircraft will enter Failsafe RTH.

## Remote Controller Status LED Description

Status LED	Sound	Remote Controller Status
— Solid green	None	Functioning normally and fully charged.
— Solid red	None	Charging (remote controller is powered off). Remote controller is not connected to the aircraft.
— Solid yellow	None	Control stick calibration error. Battery fully charged but remote controller is not connected to the aircraft.
..... Blinks red slowly	BB--BB--BB	Low battery level. Recharge the remote controller.
..... Blinks red quickly	B-B-B...	Critically low battery level, the remote controller will automatically power off after 3 seconds / The remote controller is switched on with the control stick not in the neutral position.
..... Blinks green slowly	B--B--B...	Inactivity for over 6 minutes. Switch off the remote controller if it is not in use.

## Linking the Remote Controller

The Phantom 3 SE is linked to the remote controller by default, and re-linking is only necessary if the remote controller is replaced with a new one. Refer to the figure below to locate the Link Button.

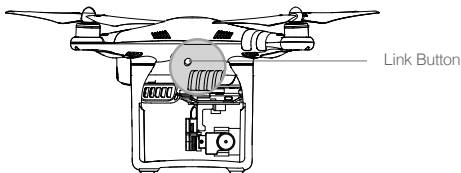

Remote Controller

### Linking Procedures

1. Turn on the aircraft and press the Link Button. The button will blink red when the aircraft is ready to link.
2. Switch on the remote controller, turn the gimbal dial to the far left, and toggle the S2 switch back and forth quickly for at least three times. You will hear a pulsating beep sound when the remote controller is trying to link to the aircraft.
3. The remote controller will stop beeping and the Link Button on the aircraft will turn solid green if linking is successful.

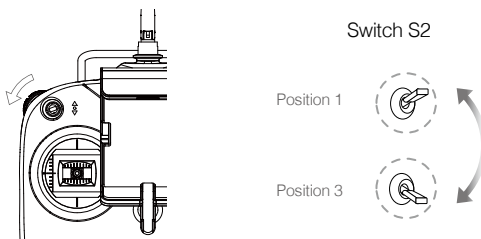

### Linking Status

Link Button	Description	User Action
— Glows solid red	No RC signal	Switch on the RC or perform a linking procedure
...Blinks red	Ready to link	Switch on the RC
— Glows solid green	Linked to RC	Linking successful

## Remote Controller Compliance Version

The remote controller is compliant with FCC, SRRC and CE requirements.

## Camera and Gimbal

---

This section provides the technical specifications of the camera and explains the gimbal's operation modes.

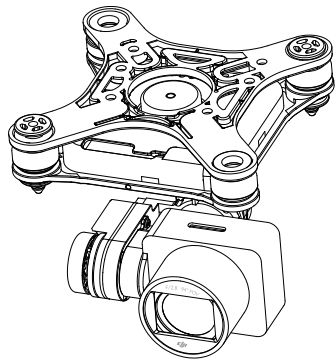

# Camera and Gimbal

## Camera Profile

The on-board camera uses the 1/2.3 inch CMOS sensor to capture video (up to 4K at up to 30fps with the Phantom 3 SE) and 12 megapixel stills. You may choose to record the video in either MOV or MP4 format. Available picture shooting modes include burst, continuous, and interval shot. A live preview of what the camera sees can be monitored on the connected mobile device via the DJI GO app.

## Camera Micro SD Card Slot

To store your photos and videos, insert the Micro SD card into the slot, as shown below, before turning on the Phantom 3 SE. The Phantom 3 SE supports Micro-SD cards up to 64 GB. A UHS-1 Micro SD card is recommended due to their fast read and write speeds allowing you to save high-resolution video data.

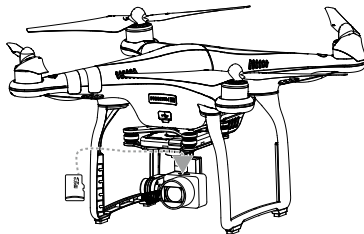

---

⊘ Do not remove the Micro SD card from the Phantom 3 SE when it is turned on.

---

## Camera Data Port

Turn on the Phantom 3 SE and connect a USB cable to the Camera Data Port to download photos and videos to your computer.











---

⚠ The aircraft must be turned on before attempting to access the files on the Micro SD card.

---

## Camera Status Indicator

Camera LED Indicator lights up after the Intelligent Flight Battery is powered on. It provides information on the working status of the camera.

Camera Status Indicator	Camera status
 Fast green flashing	System is warming up.
 Green flashing once	Taking a single picture.
 Green flashing three times	Taking 3 or 5 photos per shot.
 Slow red flashing	Recording.
 Fast red flashing	SD card error.
 Two red flashing	Overheated Camera
 Solid red	System error.
 Alternating green and red	Firmware Upgrading

## Gimbal

### Gimbal Profile

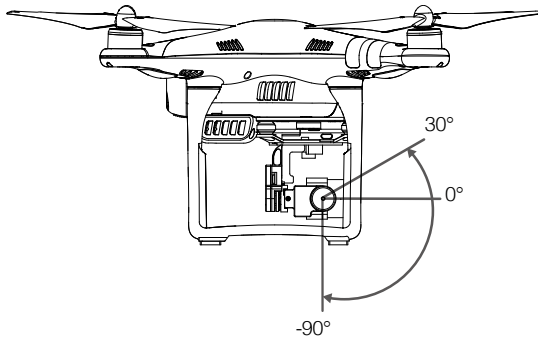

The 3-axis gimbal provides a steady platform for the attached camera, allowing you to capture clear, stable images and video. The gimbal can tilt the camera within a 120° range.



Use the gimbal dial on the remote controller to control the tilt movement of the camera.

### Gimbal Operation Modes

Two gimbal operation modes are available. Switch between the different operation modes on the camera settings page of the DJI GO app. Note that your mobile device must be connected to the remote controller for changes to take effect. Refer to the table below for details:

	 <p>Follow Mode</p>	<p>The angle between gimbal's orientation and aircraft's nose remains constant at all times.</p>
	 <p>FPV Mode</p>	<p>The gimbal will synchronize with the movement of the aircraft to provide a first-person perspective flying experience.</p>



- Always remove the gimbal lock before powering on the aircraft.
- A gimbal motor error may occur in these situations: (1) the aircraft is placed on uneven ground or the gimbal's motion is obstructed (2) the gimbal has been subjected to an excessive external force, such as a collision. Please take off from flat, open ground and protect the gimbal at all times.
- Flying in heavy fog or clouds may make the gimbal wet, leading to temporary failure. The gimbal will recover full functionality after it dries.

### Anti-Drop Kit

The anti-drop kit helps keep the gimbal and camera connected to the aircraft. Two pins have been mounted prior to shipping. If new or additional pins are required, see the diagram below. Press Part ① through the hole of the vibration absorber and into the center hole of Part ②, then lock them together as shown ③. Mounting the anti-drop kit pins diagonally from each other is recommended.

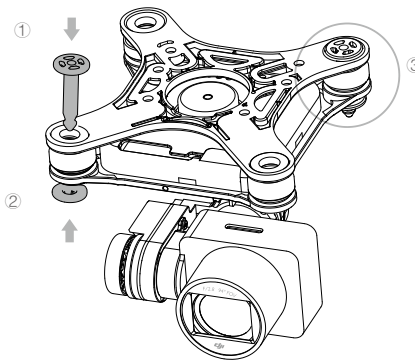



## DJI GO App

---

This section introduces the four main functions of the DJI GO app.

# DJI GO App

Use this app to control the gimbal, camera, and other aircraft functions. The app features Equipment, Editor, SkyPixel and Me sections, which are used for configuring your aircraft, editing and sharing your photos and videos with others.

## Equipment

Enter Camera View by tapping Camera on the DJI GO welcome screen.

Camera View

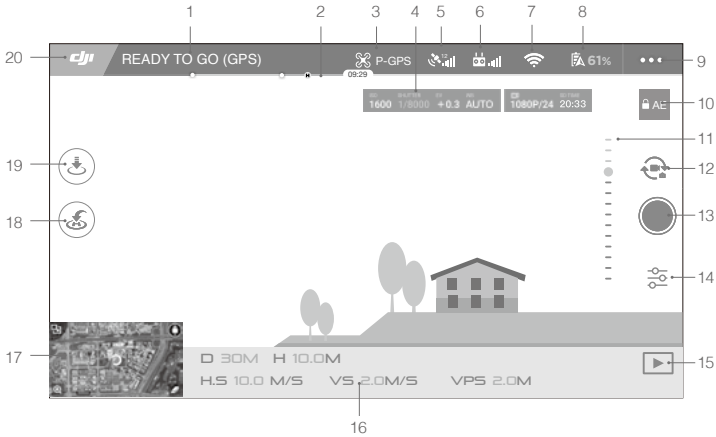

### [1] System Status

**READY TO GO (GPS)** : This icon indicates aircraft flight status and various warning messages.

### [2] Battery Level Indicator

—●—●—●— : The battery level indicator provides a dynamic display of the battery level. The colored zones on the battery level indicator represent the power levels needed to carry out different functions.

### [3] Flight Mode

☼ : The text next to this icon indicates the current flight mode.

Tap to configure the MC (Main Controller) Settings. These settings allow you to modify flight limits and set the gain values.

☼ : The aircraft is set to "Beginner Mode" by default. The aircraft cannot fly 30 meters (98 feet) higher and beyond the recorded Home Point under beginner mode. Disable this mode in the ☼ setting page.

### [4] Camera Parameters

Displays camera settings parameters and capacity of the Micro SD card.

**[5] GPS Signal Strength**

: This icon shows the current strength of GPS signals.

**[6] Remote Controller Signal**

: This icon shows the strength of remote controller's signal.

**[7] Video Downlink Signal**

: Shows the signal strength of the Wi-Fi Video Downlink between the aircraft and the remote controller. Tap to set the SSID and connection password for the Wi-Fi connection.

**[8] Battery Level**

 **100%**: This icon shows the current battery level.

Tap to view the battery information menu, set the various battery warning thresholds, and view the battery warning history.

**[9] General Settings**

: Tap this icon to view the General Settings page. From this page, you can set flight parameters, reset the camera, enable the quick view feature, adjust the gimbal roll value, and toggle the flight route display.

**[10] Auto Exposure Lock**

AE: Tap to lock the exposure value.

**[11] Gimbal Slider**

: Displays the pitch of the gimbal.

**[12] Photo/Video Button**

Tap to switch between photo and video recording modes.

**[13] Shoot/Record Button**

Tap to start shooting photos or recording video.

**[14] Camera Settings**

: Tap to set ISO, shutter and auto exposure values of the camera.

**[15] Playback**

: Tap to enter the playback page. You can preview photos and videos as soon as they are captured.

**[16] Flight Telemetry**

**D 30M**: Distance between the aircraft and the Home Point.

**H 10.0M**: Height from the ground.

**H.S 10.0 M/S**: Aircraft horizontal speed.

**V.S 2.0M/S**: Aircraft vertical speed.

[17] Map

Display the flight path of the current flight. Tap to switch from the Camera GUI to the Map GUI.



[18] Return to Home (RTH)

 : Initiate RTH home procedure. Tap to have the aircraft return to the last recorded home point.

[19] Auto Takeoff/Landing

 : Tap to initiate auto takeoff or landing.

[20] Back

 : Tap to return to the main GUI.

## Editor

An intelligent video editor is built into the DJI GO app. After recording several video clips and downloading them to your mobile device, go to Editor on the home screen. You can then select a template and a specified number of clips which are automatically combined to create a short film that can be shared immediately.

## SkyPixel

View and share the photos and videos in the SkyPixel page.

## Me

If you already have a DJI account, you will be able to participate in forum discussions, and share your creation with the community.

# Flight

---

This section describes safe flight practices and flight restrictions.

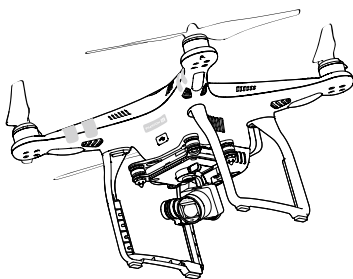

# Flight

Once pre-flight preparation is complete, it is recommended that you use the flight simulator in the DJI GO app to hone your flight skills and practice flying safely. Ensure that all flights are carried out in an open area.

## Flight Environment Requirements

1. Do not use the aircraft in severe weather conditions. These include wind speeds exceeding 10 m/s , snow, rain and fog.
2. Only fly in open areas. Tall structures and large metal structures may affect the accuracy of the on-board compass and GPS system.
3. Avoid obstacles, crowds, high voltage power lines, trees, and bodies of water.
4. Minimize interference by avoiding areas with high levels of electromagnetism, including base stations and radio transmission towers.
5. Aircraft and battery performance is subject to environmental factors such as air density and temperature. Be very careful when flying at altitudes greater than 19, 685 feet (6000 meters) above sea level, as the performance of the battery and aircraft may be affected.
6. The Phantom 3 SE cannot operate within the polar areas.

## Flight Limits and No-Fly Zones

All unmanned aerial vehicle (UAV) operators should abide by all regulations set forth by government and regulatory agencies including the ICAO and the FAA. For safety reasons, flights are limited by default, which helps users operate this product safely and legally. Flight limitations include height limits, distance limits, and No-Fly Zones.

When operating in P-mode, height limits, distance limits, and No-Fly Zones function concurrently to manage flight safety. In A-mode, only height limits are in effect, which by default prevent the aircraft altitude from exceeding 1640 feet (500 m) .

### Maximum flight altitude & Radius Limits

Maximum flight altitude and radius limits may be changed in the DJI GO app. Be aware that the maximum flight altitude cannot exceed 1640 feet (500 meters). In accordance with these settings, your Phantom 3 SE will fly in a restricted cylinder, as shown below:

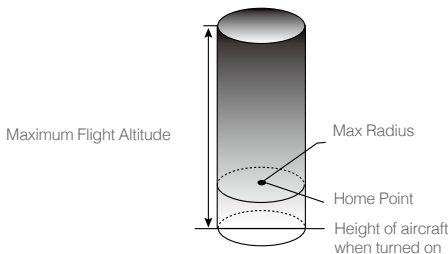

GPS Signal Strong  ..... Blinking Green

	Flight Limits	DJI GO app	Aircraft Status Indicator
Maximum Flight Altitude	Aircraft's altitude cannot exceed the specified value.	Warning: Height limit reached.	None.
Max Radius	Flight distance must be within the max radius.	Warning: Distance limit reached.	Rapid red flashing  .....

GPS Signal Weak  ..... Blinking Yellow

	Flight Limits	DJI GO app	Aircraft Status Indicator
Maximum Flight Altitude	Height is restricted to 400 feet. (120m) and under.	Warning: Height limit reached.	None.
Max Radius	No limits		



- If you fly out of the limit, you can still control the aircraft, but cannot fly it any farther. If the aircraft flies out of the max radius in Ready to Fly (non-GPS) mode, it will fly back within range automatically.
- If the aircraft flies out of the max radius in Ready to Fly (non-GPS) mode, it will fly back within range automatically.

## No-Fly Zones

All No-Fly Zones are listed on the DJI official website at <http://www.dji.com/flysafe/no-fly>. No-Fly Zones are divided into Airports and Restricted Areas. Airports include major airports and flying fields where manned aircraft operate at low altitudes. Restricted Areas include border lines between countries or sensitive institute. The details of the No-Fly Zones are explained as follow:

## Preflight Checklist

1. Remote controller, Intelligent Flight Battery, and mobile device are fully charged.
2. Propellers are mounted correctly and firmly.
3. Micro SD card has been inserted, if necessary.
4. Gimbal is functioning normally.
5. Motors can start and are functioning normally.
6. The DJI GO app is successfully connected to the aircraft.

## Calibrating the Compass

Only calibrate the compass when the DJI GO app or the status indicator prompt you to do so. Observe the following rules when calibrating your compass:

- DO NOT calibrate your compass where there is a chance of strong magnetic interference, such as magnetite, parking structures, and steel reinforcements underground.
- DO NOT carry ferromagnetic materials with you during calibration such as cellular phones.
- The DJI GO app will prompt you to resolve the compass issue if the compass is affected by strong interference after calibration is complete. Follow the prompted instructions to resolve the compass issue.

### Calibration Procedures

Choose an open area to carry out the following procedures.

1. Ensure that the compass is calibrated. If you did not calibrate the compass as part of your pre-flight preparations, or if you have moved to a new location since the last calibration, tap the Aircraft Status Bar in the app and select "Calibrate", then follow the on-screen instructions.
2. Hold the aircraft horizontally and rotate 360 degrees. The Aircraft Status Indicators will display a solid green light.

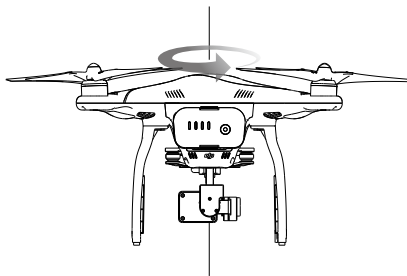



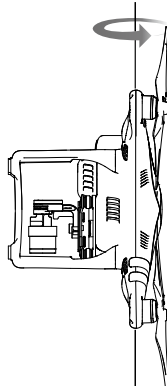

3. Hold the aircraft vertically, with nose pointing downward, and rotate it 360 degrees around the center axis.



4. Re-calibrate the aircraft if the aircraft status indicators blink red.

 If the Aircraft Status Indicator blinks red and yellow after the calibration procedure, move your aircraft to a different location and try again.

-  • DO NOT calibrate the compass near metal objects such as a metal bridge, cars, scaffolding.  
• If the aircraft status indicator is blinking red and yellow alternately after placing the aircraft on the ground, the compass has detected magnetic interference. Change your location.

## Auto Takeoff and Auto Landing

### Auto Takeoff

Use auto takeoff only if the Aircraft Status Indicators are blinking green. Follow the steps below to use the auto takeoff feature:

1. Launch the DJI GO app, and enter "Camera" page.
2. Ensure the aircraft is in P- mode.
3. Complete all steps on the pre-flight checklist.
4. Tap , and confirm that conditions are safe for flight. Slide the icon to confirm and takeoff.
5. Aircraft takes off and hovers at (1.2 meters) above ground.

 Aircraft Status Indicator blinks rapidly when it is using the Vision Position System for stabilization. The aircraft will automatically hover below 3 meters. It is recommended to wait until there is sufficient GPS lock before using the Auto Take-off feature.

### Auto-Landing

Use auto-landing only if the Aircraft Status Indicators are blinking green. Follow the steps below to use the auto-landing feature:

1. Ensure the aircraft is in P- mode.
2. Check the landing area condition before tapping , to begin landing. Then follow the on-screen instructions.

## Starting/Stopping the Motors

### Starting the Motors

A Combination Stick Command (CSC) is used to start the motors. Push both sticks to the bottom inner or outer corners to start the motors. Once the motors have started spinning, release both sticks simultaneously.

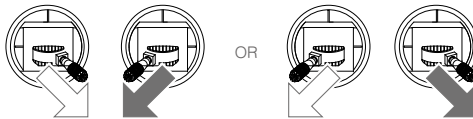

### Stopping the Motors

There are two methods to stop the motors.

Method 1: When the aircraft has landed, push and hold the throttle down. The motors will stop after three seconds.

Method 2: When Phantom 3 SE has landed, push the throttle down ①, then conduct the same CSC that was used to start the motors, as described above ②. Motors will stop immediately. Release both sticks once motors stop.

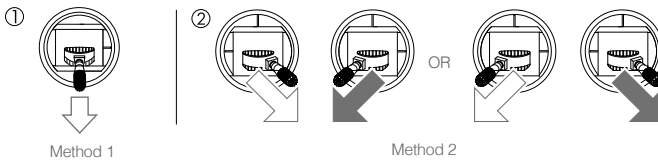

Flight



- It is recommended to use method 1 to stop motors.
- Do not perform a CSC when the aircraft is in midair, otherwise the motors will suddenly stop.

## Flight Test

### Takeoff/Landing Procedures

1. Place the aircraft in an open, flat area with the battery level indicators facing towards you.
2. Turn on the remote controller and your mobile device, then turn on the Intelligent Flight Battery.
3. Launch the DJI GO app and enter the Camera page.
4. Wait until the Aircraft Indicators blink green. This means the Home Point is recorded and it is now safe to fly. If they flash yellow, the Home Point has not been recorded.
5. Push the throttle up slowly to take off or use Auto Takeoff.
6. Shoot photos and videos using the DJI GO app.
7. To land, hover over a level surface and gently pull down on the throttle to descend.
8. After landing, hold the throttle at its lowest position until the motors stop.
9. Turn off the Intelligent Flight Battery first, then the Remote Controller.



- When the Aircraft Status Indicators blink yellow rapidly during flight, the aircraft has entered Failsafe mode.
  - A low battery level warning is indicated by the Aircraft Status Indicators blinking red slowly or rapidly during flight.
  - Watch our video tutorials for more flight information.
- 

### Video Suggestions and Tips

1. Go through the full pre-flight checklist before each flight.
2. Select the desired gimbal operation mode in the DJI GO app.
3. Only shoot video when flying in P-mode.
4. Always fly in good weather and avoid flying in rain or heavy wind.
5. Choose the camera settings that suit your needs. Settings include photo format and exposure compensation.
6. Perform flight tests to establish flight routes and preview scenes.
7. Push the control sticks gently to keep the aircraft's movement smooth and stable.

# Appendix

---

# Appendix

## Specifications

### Aircraft

Weight (Battery & Propellers Included)	1236 g
Max. Ascent Speed	5 m/s
Max. Descent Speed	3 m/s
Max. Speed	16 m/s (ATTI mode, no wind)
Max Service Ceiling Above Sea Level	6000 m (Software altitude limit: 120 m above takeoff point)
Max. Flight Time	Approximately 25 minutes
Operating Temperature	0°C to 40°C
GNSS	GPS+GLONASS
Operating Frequency	2.400-2.4835 GHz; 5.725-5.850 GHz
Transmitter Power (EIRP)	2.4 GHz: ≤27 dBm (FCC); ≤20 dBm (SRRC); ≤20 dBm (CE) 5.8 GHz: ≤30 dBm (FCC); ≤26 dBm (SRRC); ≤14 dBm (CE)

### Gimbal

Controllable Range	Pitch: - 90° to + 30°
--------------------	-----------------------

### Vision Positioning

Velocity Range	< 8 m/s (2 m above ground)
Altitude Range	30 cm-300 cm
Operating Range	50 cm-300 cm
Operating Environment	Surface with clear pattern and adequate lighting (Lux > 15)

### Camera

Sensor	1/2.3" CMOS Effective pixels: 12 M
Lens	FOV 94° 20mm (35mm format equivalent ) f/2.8 Focus at Infinity
ISO Range	100-3200(video) 100-1600(photo)
Electronic Shutter Speed	8s - 1/8000s
Image Max. Size	4000 × 3000

	Single shot
	Burst shooting: 3/5/7 frames
Still Photography Modes	Auto Exposure Bracketing (AEB): 3/5 bracketed frames at 0.7EV Bias Interval

	C4K: 4096×2160 24/25p
	4K: 3840×2160 24/25/30p
Video Recording Modes	2.7K: 2704×1520 24/25/30p FHD: 1920×1080 24/25/30/48/50/60p HD: 1280×720 24/25/30/48/50/60p

Max. Bitrate Of Video Storage	60 Mbps
Supported File Formats	FAT32 (≤ 32 GB) ; exFAT (> 32 GB)
Photo Formats	JPEG, DNG
Video Formats	MP4/MOV (MPEG-4 AVC/H.264)
Supported SD Card Types	Micro SD, Max. capacity: 64 GB. Class 10 or UHS-1 rating required

<b>Remote Controller</b>	
Operating Frequency	2.400-2.483 GHz; 5.725-5.85 GHz
Transmitter Power (EIRP)	2.4 GHz: ≤27 dBm (FCC); ≤20 dBm (SRRC); ≤20 dBm (CE)
	5.8 GHz: ≤30 dBm (FCC); ≤26 dBm (SRRC); ≤14 dBm (CE)
Max Transmission Distance (Unobstructed and free of interference)	2.4 GHz: 0.6 mi (1000 m, FCC); 0.3 mi (500 m, SRRC); 0.3 mi (500 m, CE)
	5.8 GHz: 2.5 mi (4000 m, FCC); 1.9 mi (3000 m, SRRC); 0.2 mi (400 m, CE)
Operating Temperature Range	32° to 104° F (0° to 40° C)
Battery	2600 mAh LiPo 18650
Mobile Device Holder	Tablets and smartphones
<b>Charger</b>	
Voltage	17.4 V
Rated Power	57 W
<b>Intelligent Flight Battery ( PH3-4480 mAh-15.2 V )</b>	
Capacity	4480 mAh
Voltage	15.2 V
Battery Type	LiPo 4S
Energy	68 Wh
Net Weight	365 g
Charging Temperature Range	5°C–40°C
Max. Charging Power	100 W

## Firmwares Update

Connect to the Internet, launch the DJI GO app. The DJI GO app will start checking for available firmware updates automatically. Follow the on-screen instruction to update the latest firmware for the aircraft, remote controller and intelligent flight battery.

## Intelligent Flight Mode

Intelligent Flight mode includes Course Lock, Home Lock, Point of Interest (POI), Follow Me and Waypoints features to assist users to create professional shoots during the flight. Course Lock and Home Point lock helps to lock the orientation of aircraft so that the user can focus more on other operations. Point of Interest, Follow Me and Waypoints mode enable aircraft to fly automatically according to the pre-set flight maneuvers.

Course Lock	Lock the current nose direction as the aircraft's forward direction. The aircraft will move in the locked directions regardless of its orientation (yaw angle).
Home Lock	Pull the pitch stick backward to move the aircraft toward its recorderd Home Point.
Point of Interest	The aircraft will orbit around the subject automatically to allow the operator can be more focus on framing their shoot on the subject in Point of Interest.
Follow Me	A virtual tether is created between the aircraft and the mobile device so that the aircraft can track your movement as you move. Note that Follow Me performance is subject to the GPS accuracy on the mobile device.
Waypoints	Record a flight path, then the aircraft will fly along the same path repeatedly while you control the camera and orientation. The flight path can be saved and re-apply in the future.

Enable Multiple Flight Mode by launching the DJI GO app > Camera View >  > Advanced Settings > Multiple Flight Mode before using the Intelligent Flight Mode for the first time.

## After-Sales Information

Visit the following pages to learn more about After-sales policy and warranty information:

1. After-sales Policy: <http://www.dji.com/service>
2. Refund Policy: <http://www.dji.com/service/refund-return>
3. Paid Repair Service: <http://www.dji.com/service/repair-service>
4. Warranty Service: <http://www.dji.com/service/warranty-service>

If you have any questions about this document, please contact DJI by sending a message to **DocSupport@dji.com**.